

VV9

Bruksanvisning
Brugsanvisning
Bruksanvisning

Käyttöohjeet
Bedienungsanleitung
Instruction for use

N DK S
FIN D GB

1.

**NB! OBS!
HUOM!**

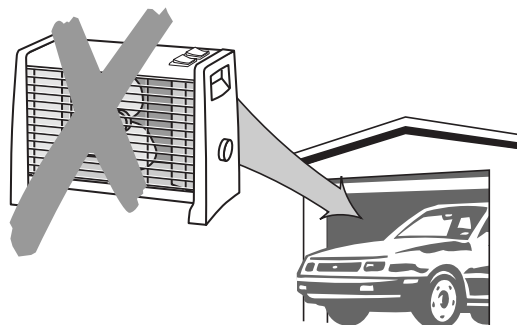
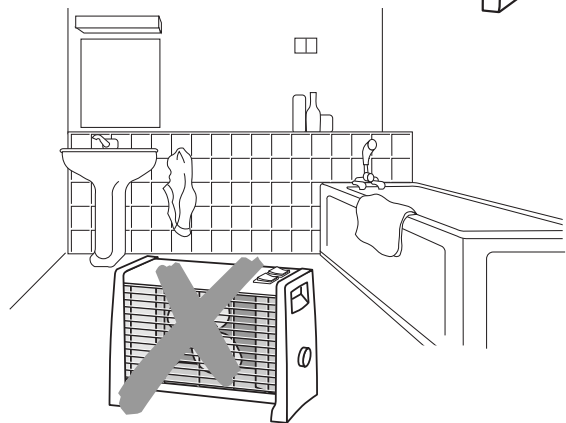
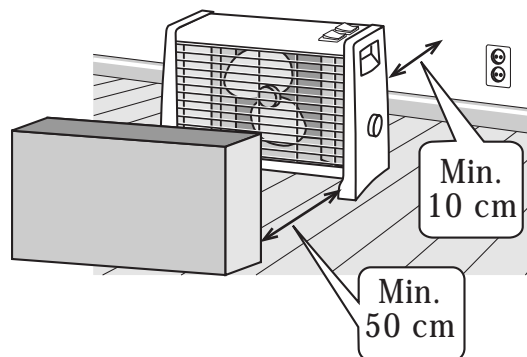
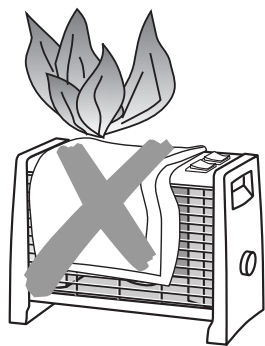

2.

	P (Watt)		
	I	II	I+II
VV9/ VV9T	800	1200	2000 (800+1200)

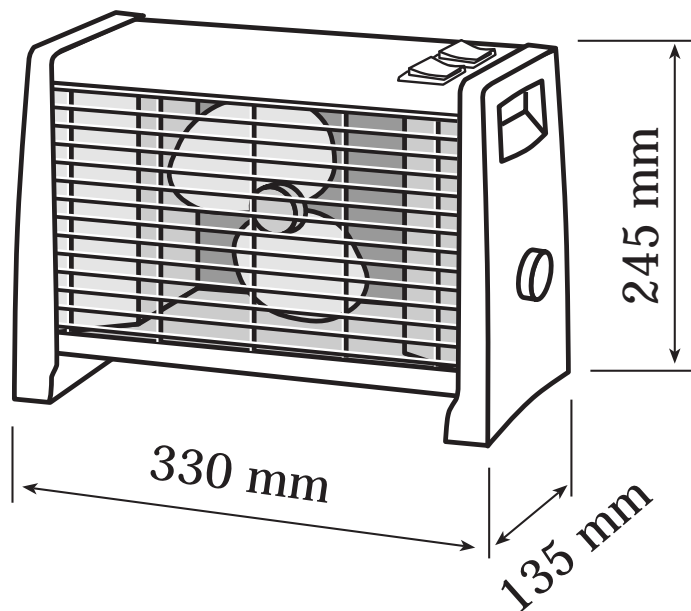

VV9

Bruksanvisning
Brugsanvisning
Bruksanvisning

Käyttöohjeet
Bedienungsanleitung
Instruction for use

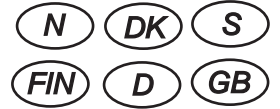

3.

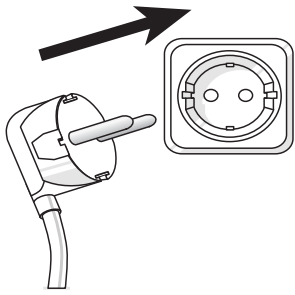

230V, 50 Hz, IP20

5.

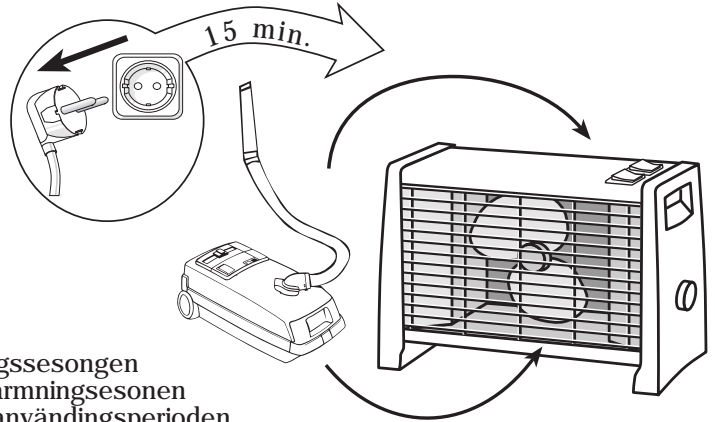

Rengjøres hver måned i fyringssesongen
Rengøring hver måned i oppvarmingsesonen
Rengörs varje månad under användningsperioden
Puhdistetaan kuukausittain käyttöaikana
Reinigung, 1x im Monat während der Heizperiode
Clean each month during period of use

4.

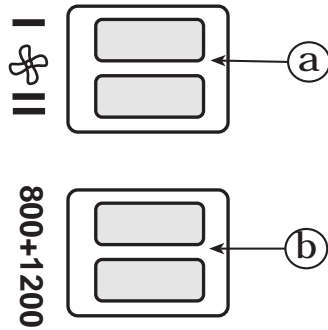

800+1200

1 = 3-7°C
4 = 13-17°C
7 = 22-27°C
10 = 32-37°C

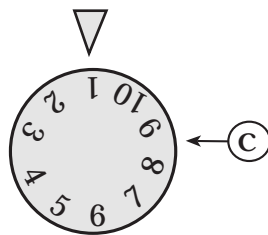

a. Vifte, Ventilator, Fläkt, Puhallin, Lüfter, Fan
b. Varme, Varme, Värme, Lämmin, Heize, Heat
c. Termostat, Termostat, Termostat, Termostaatin, Termostat, Thermostate

6.

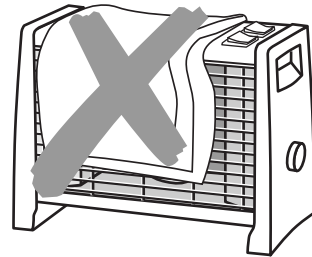

Réset av overtemperatursikring
Réset, overtemperatursikring
Återställning av överhettningsskydd
Ylikuumentemissuojan palautuspainike
Reset, Übertemperatursicherung
Resetting the overheating cut-out

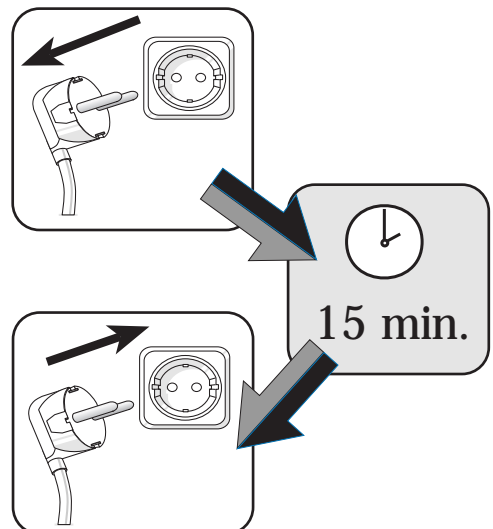

1 ВНИМАНИЕ!



Забележка:
Този символ означава
"Не покривай!"

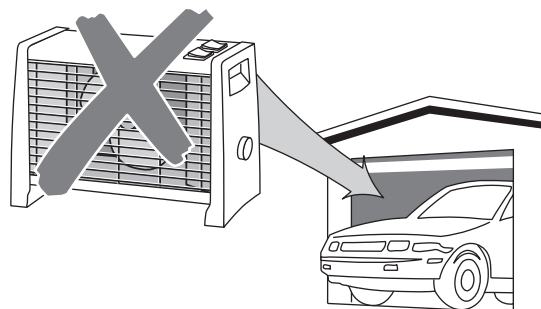
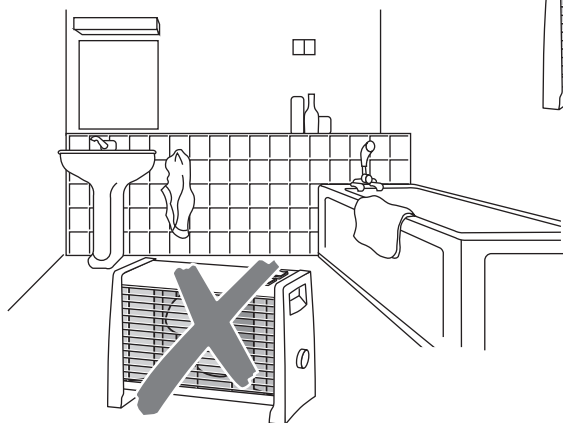
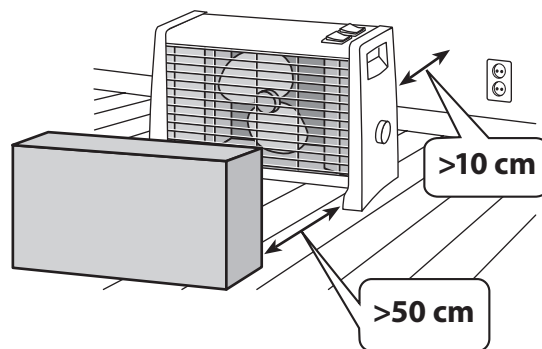
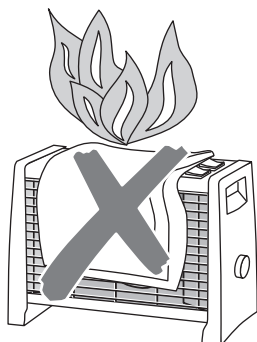

2

	P (Вт)		
	I	II	I+II
VV9 / VV9T	800	1200	2000 (800+1200)

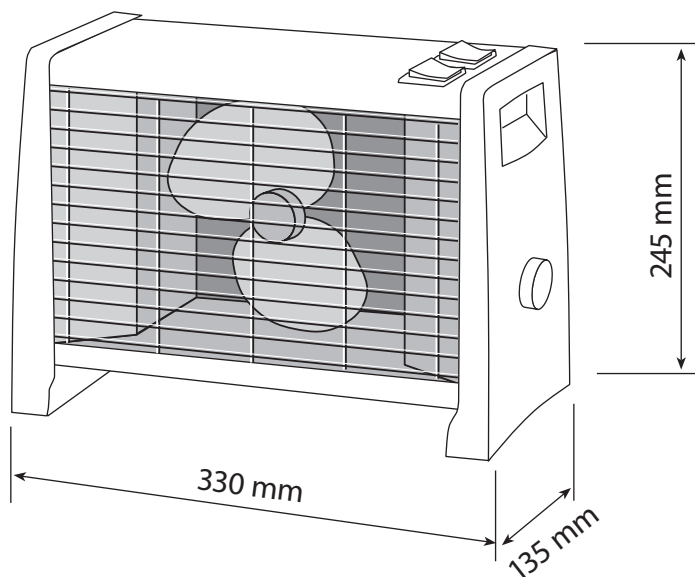

Сервиз:

Термокс ЕООД, София 1606, ул. Йоаким Кърчовски № 8, тел: 02/ 9533597

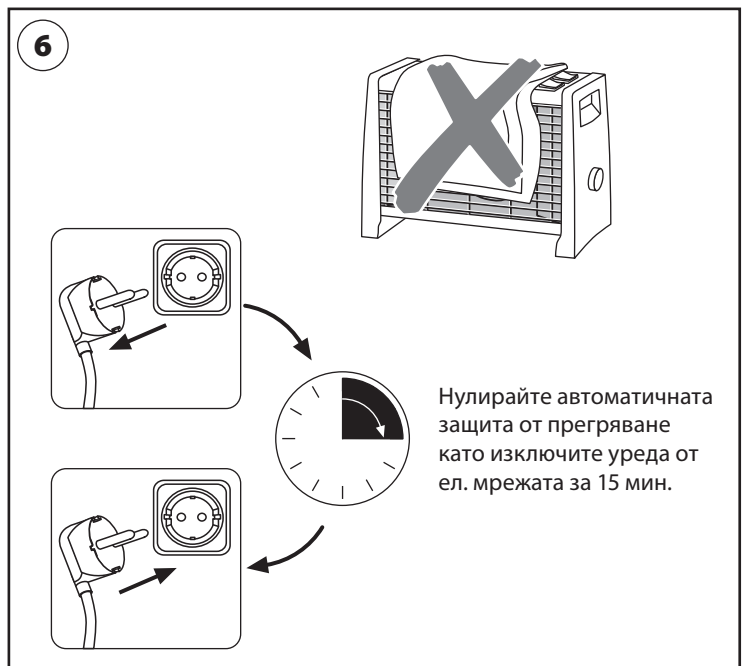
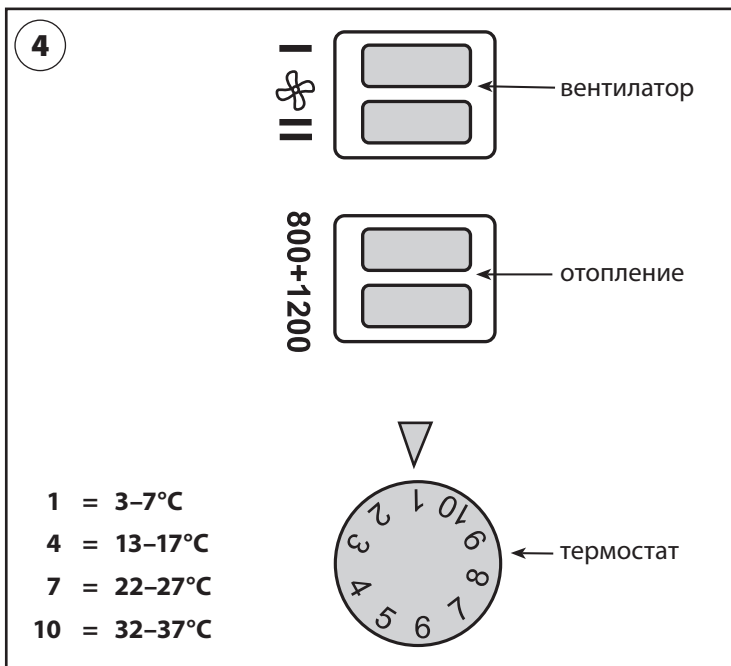
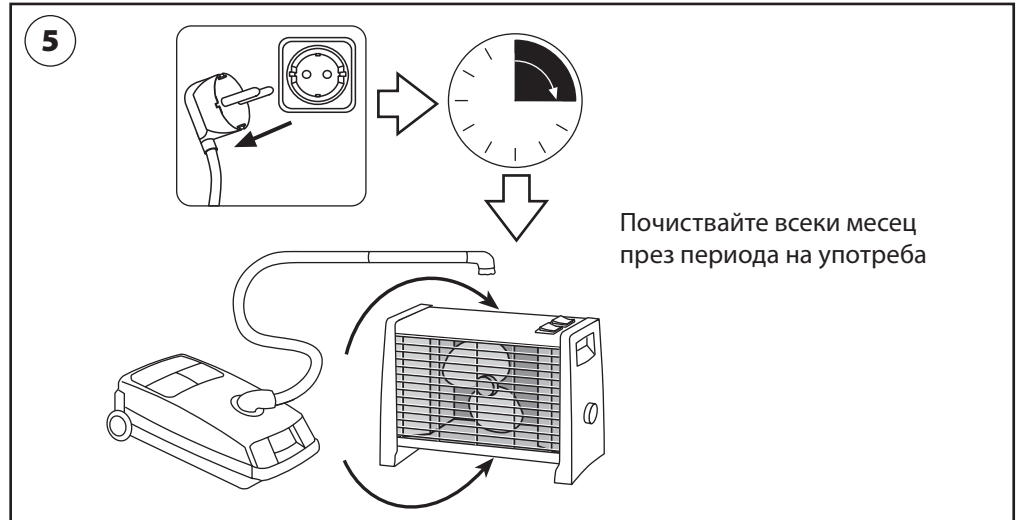
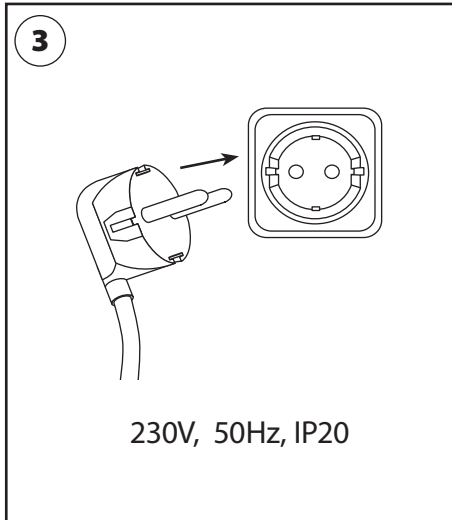

Уредът не е предназначен за употреба от лица (вкл. деца) с ограничени физически, сетивни или умствени способности или недостатъчно опит и познания, освен ако не им е осигурено наблюдение или указание касаещо употребата на уреда от лице отговорно за тяхната безопасност.

Децата трябва да се наблюдават и да не се допуска да си играят с уреда.

Ако захранващият кабел се повреди, той трябва да се подмени от производителя, неговия сервизен агент или от квалифицирано лице с подобна квалификация, за да се предотврати опасност.